

THE EFFECT OF TIP FORCE ON WELD QUALITY AND ELECTRODE LIFE

By:
Roger B. Hirsch, President
Ronald Leibovitz, V.P. Manufacturing
Unitrol Electronics, Inc.
Northbrook, IL USA

ABSTRACT:

High production resistance welding introduces the requirement of both quality as well as electrode life on often unmanned welding stations. While values of TIP FORCE are specified in various resistance welding charts (ie. AWS, RWMA, GM, FORD, etc.), the actual application of these values is often not followed. Welding before required force has been reached is quite common on high speed production lines. Squeeze time is often the only tool used to allow systems to reach proper welding force in both production and manual systems.

This paper will first explain the relationship between air pressure and electrode force for various types of pneumatic welding systems. It will then examine the dynamics of weld force creation during a typical weld cycle.

Methods of electrode force measurement during welding will be shown with advantages and disadvantages of each technology.

Next will be an examination of how electrode force effects weld strength and physical appearance. The influence of dynamic change of electrode force during welding will be covered along with methods available to minimize this change.

Also included will be a study showing how high electrode force effects weld strength on both CRS and galvanized steel.

HISTORICAL BACKGROUND:

The basic resistance welding process has not changed appreciably since the early part of the century. At its most basic, it consists of passing electrical current through two or more layers of metal that are being held together by force. When current passes through this "sandwich", the metal is heated and coalesces. This process is a controlled combination of melting and forging.

THE EFFECT OF ELECTRODE FORCE IN THE RW PROCESS

As seen in FIGURE 1¹, when an electrical current passes through the weld zone, metal is heated to a point just slightly above the metal's melting temperature. It is this very localized melting that causes a very strong but small joint area between parts. If applied properly, the lower electrical resistance and "chill" effect of the electrodes on the outer surfaces keeps temperatures below the melting point of the copper electrode.

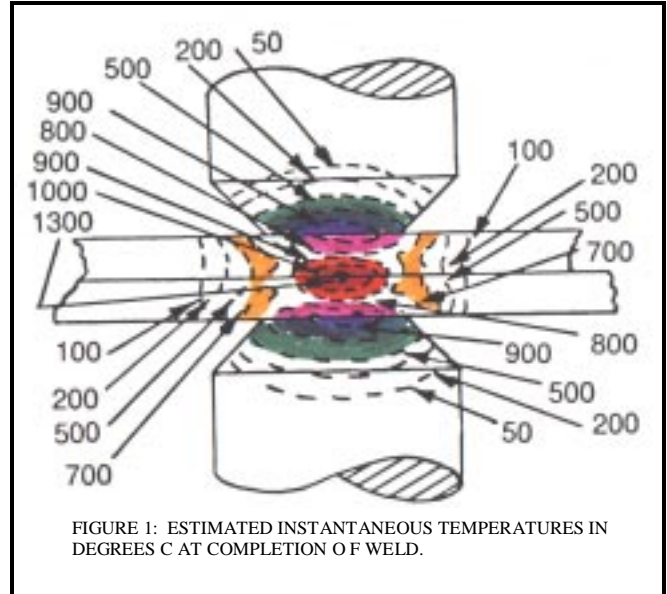

FIGURE 1: ESTIMATED INSTANTANEOUS TEMPERATURES IN DEGREES C AT COMPLETION OF WELD.

LOW ELECTRODE FORCE:

The electrode force must be high enough to contain this molten metal within the parameters of the electrode face. If the force is too **LOW**, six main things happen:

1. **EXTERNAL EXPULSION:** Because the contact force between the electrode face and the outer surface of the metal is **low**, the electrical resistance will be **high**. Heat created in the resistance welding process can be expressed by the classic equation:

$$I^2rt$$

where:

I = electrical current

r = electrical resistance

t = time of electrical current passage

It can be seen from this equation that a high resistance (r) at any point in the electrode/metal/metal/electrode sandwich of a resistance weld process, high resistance will create high heat. If this occurs at the contact between the electrode and the outer side of the metal, excessive heat will be created.

Since this molten metal is electrically charged at any instant in the same polarity as the metal sheet, most of this molten metal will be magnetically propelled away from the electrode area to cause expulsion ("flash").

It should be noted that expulsion also occurs when the welding time is too long and the molten metal inside the nugget area finally reaches the outer skin of the metal being welded.

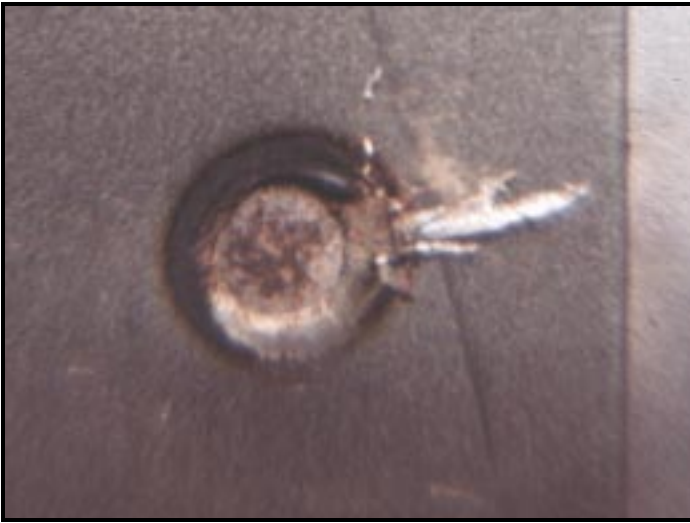

Other than the obvious potential danger to the operator and anyone else in the area, resultant welds tend to have deep and irregular indentations often requiring extensive secondary operations to improve appearance. Additionally, any of the molten metal that is not expelled from the electrode area remains on the sheet as either deep craters or sharp metal formations.

2. **EXCESSIVE ELECTRODE INDENTATION:** When electrode indentation is observed, many operators will assume that the electrode force is causing this problem and will lower the force. In actual fact, these surface dents are caused by this surface softening of the metal and can be minimized by **increasing** the force. This low force condition can also cause a hole to be blown through the parts, or cause pits to be burned into the electrode face. In addition, deep indentation of the nugget means that the cross sectional area of the nugget is considerably thinner than the parent material to greatly reduce the nugget tensile.

3. **INTERNAL EXPULSION:** Since the force is not high enough to contain molten metal within the nugget zone, metal expulsion occurs between the sheets. The flash also pushed the sheets apart to make room for the solidified metal.

4. **ELECTRODE DAMAGE:** Excessive heat generated at the surface interface of the electrode and part causes the copper transfer to the steel on each weld. This results in moving the welding face into the electrode and thereby increasing the face diameter.

FIGURE 2 shows two sectioned electrodes after 8,000 welds with proper force (A), and with low force (D). Both were cooled with 55°F water at 1.2 gpm. and made 8,000 welds at a rate of 54 welds per minute. The electrode diameter has

increased because material has been removed by by melting and expulsion rather than by mushrooming. Notice that the edges of electrode D are almost square and not mushroomed as in the earlier study of higher temperature water.

The electrode face diameter on the electrode operated at 650lb. went from the original .250 to .285 producing a 14% increase.

The electrode operated at 335 lb. increased in diameter from the original .250 to a final .373. for a 49.2% increase. It should be noted that the electrode diameter was very irregular and hard to measure.

4. **INCONSISTENT WELDS:** On **thick** or **poor fitting** parts, force is required to establish a current path just under the electrodes. In fact, the electrodes are required to force the sheets together in a more intimate contact at the nugget area to prevent current paths around the weld zone. While the area under the electrodes will eventually come in contact, a portion of welding time will have already been consumed trying to heat areas outside of the weld zone. Therefore the weld strength will vary considerably from weld to weld.



5. **POOR PROJECTION WELDS:** At the early stages of nugget development in welding parts with **projections**, low force will create very **small** area contact to create very **high current density** at the tip of the projection. This will cause the tip of the projection to be blown away as expulsion ("flash") to therefore reduce the final nugget cross sectional area.

When making multiple projections, this problem is exasperated and leads to the need for micro adjustment of electrode parallelism. However no matter how perfect the mechanical setup can be made, it is virtually **impossible** to get all welds in a multiple projection group to each have good tensile and ductility when low electrode force is being used.

TEST RUN UNDER LOW FORCE CONDITIONS

A run of 8,000 welds on .050 CRS bare was made to examine the effect on electrode conditions under low force conditions. The welder control was set in the constant voltage mode and utilized a transducer within the welder control to accurately start current flow at the selected force. The welder air regulator was set to produce electrode forces of 650lb. for the regular run, and 325 lb. for the low force test.

The control was set to for the following parameters:

SQUEEZE TIME = 00 (fires from transducer)
WELD TIME = 12 cycles
WELD CURRENT - 10,500 amps
HOLD TIME = 03 cycles
ELECTRODE FORCE = 650 lb. / 325 lb.

WELDER CONDITIONS:

Rate = 54 welds per minute
Cooling water = 55°F water at 1.2 gpm.

Results of these tests are shown in GRAPH 1 through GRAPH 3. The welds produced included a major amount of metal burrs around the edges, and the interior of the nugget pocket was rough.

GRAPH 1 shows weld TENSILE strength results of both runs. The obvious problem observed here is that the results on the low force run were **erratic**. Some welds actually measured slightly higher in tensile than the comparable weld with correct force. This was caused by excessive (but uncontrolled) localized heating. Others dropped dramatically. While no stable pattern can be observed, the final tensile was 20.9% lower than the initial value.

GRAPH 2 shows the NUGGET diameter measurements of the two runs. Again, the low force run exhibited erratic results to reinforce the tensile measurement variations. Measurement of weld 8,000 yielded a nugget diameter 19.3% smaller than the initial weld. However it should be noted from the graph that there was no clean pattern for nugget diameter, and nuggets were very irregular in shape and difficult to measure with any accuracy.

GRAPH 3 shows the ELECTRODE growth of both runs. FIGURE 3 shows the actual electrodes after the two 8,000 weld runs. The electrode face diameter for the 650lb. force run went from the original .250 to .285 producing a 14% increase in a clean and controlled pattern. Conversely, the electrode face diameter for the 325 lb. force run increased in diameter from the original .250 to a final .373. for a 49.2% increase. The pattern of change was not consistent, and the electrode face was irregular and difficult to measure accurately.

Electrode sticking occurred from the beginning of the run on

the low force welds.

For the 650 lb. run, no sticking was observed throughout the 8,000 weld run. The appearance of weld 8,000 in this 650 lb. run was almost identical to the first weld in this series.

HIGH ELECTRODE FORCE:

If the electrode force is too high, electrical resistance at the faying surface will be comparatively low thus reducing the heat created in this zone. Nuggets formed with high electrode force typically exhibit shallow penetration and low ductility.

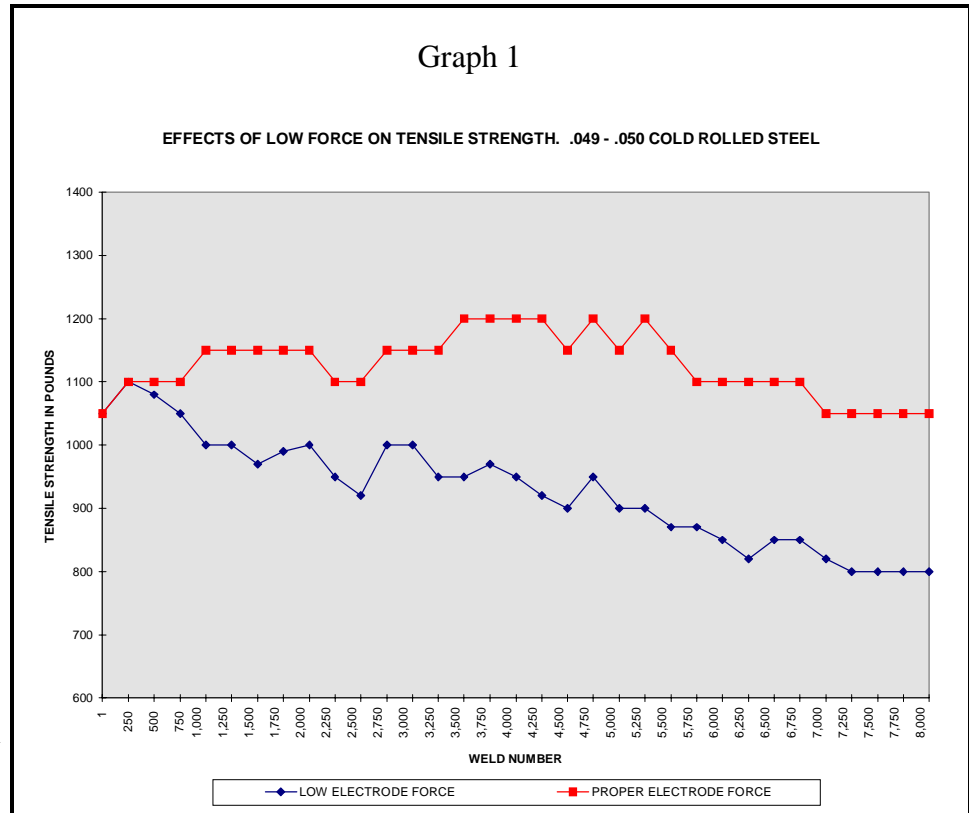

HIGH FORCE TEST ON .029 CRS

The following welding schedule was used:

SQUEEZE TIME = 00 (fires from transducer)
WELD TIME = 8 cycles
WELD CURRENT = 8,200
HOLD TIME = 03 cycles
ELECTRODE FORCE = 400 lb. to 1,100 lb.

CHART 1 shows the results of a test on .029 CRS, bare steel. The drop in TENSILE with increased electrode force is dramatic.

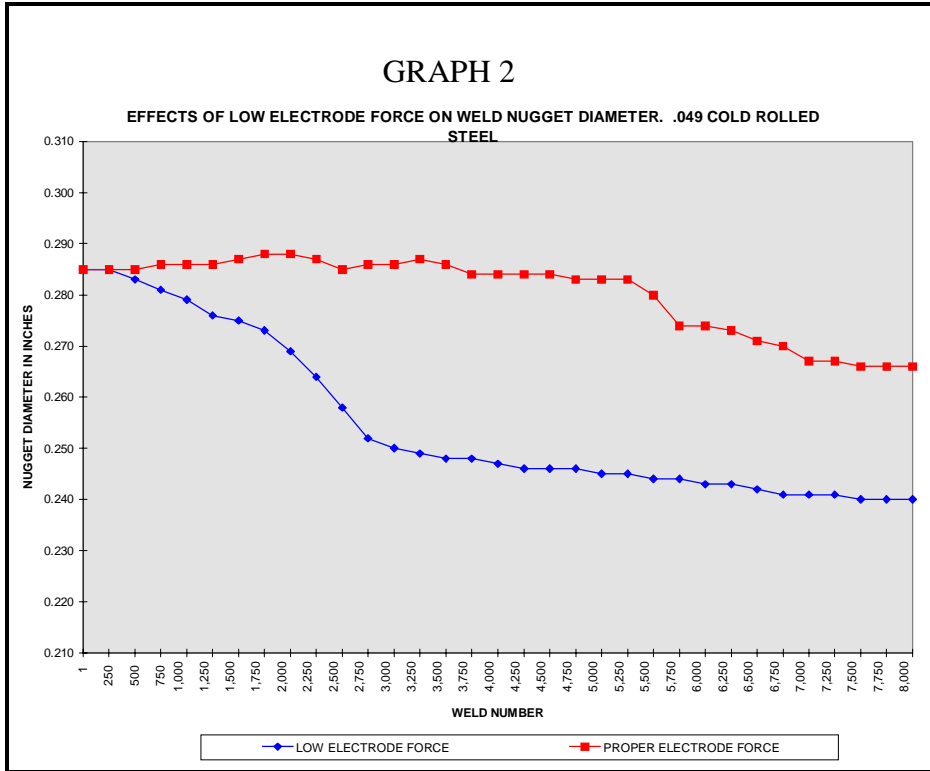

SQUEEZE TIME = 00 (fires from transducer)
 WELD TIME = 12 cycles
 WELD CURRENT = 9,800
 HOLD TIME = 03 cycles
 ELECTRODE FORCE = 650 lb. to 1,500 lb.

CHART 2 tracks the TENSILE strength for coupons at various tip force values. The tensile values roll off quickly as shown on this chart. CHART 2 also compares NUGGET diameter to electrode force. At an increase of 15% (750 lb.), the nugget was cut 42%. At the 950 weld test and forward, welds were only surface and lacked enough penetration to pull any nugget. All of the samples over 950 lb. electrode force broke apart on the tensile tester.

HIGH FORCE TEST ON .031 G90 STEEL

A series of welds were made on .031 Galvanized steel coupons using the following schedule.

SQUEEZE TIME = 00 (fires from transducer)
 PREHEAT TIME = 08 cycles
 PREHEAT CURRENT = 7,200 amps
 DELAY AFTER PREHEAT = 5 cycles
 WELD TIME = 10 cycles
 WELD CURRENT = 11,480
 HOLD TIME = 03 cycles
 ELECTRODE FORCE = 420 lb. to 920 lb.

CHART 1 also equates electrode force to NUGGET diameter. The nuggets formed under the higher force were very fragile and resulted in small irregular nuggets. This confirms that penetration is very shallow on these nuggets. On the 920 lb. force weld, the coupons fell apart when handled. Only surface roughness in the nugget area showed where heat had passed through the parts. Parts welded with the higher force exhibited almost no ductility in the weld.

HIGH FORCE TEST ON .050 CRS

Welds were made on .050 CRS, bare steel. The weld schedule used was:

The sequence was: PREHEAT, COOL, WELD, HOLD.

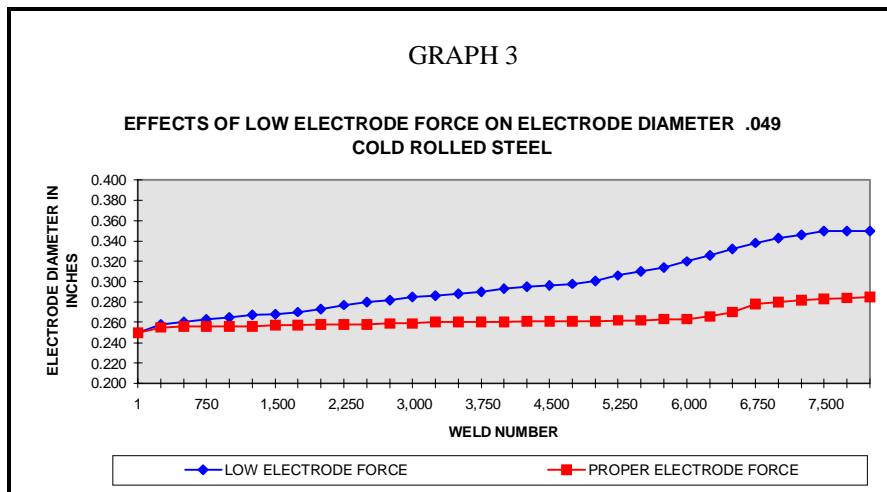

This program produced the best welding results by far over UPSLOPE or PULSATION sequences prior to data collection for this paper and was, therefore, chosen for these runs..

CHART 3 tracks TENSILE strength results of various electrode force values. As can be seen in the graph, the strength rolloff is extreme as shown.

One important observation of this test is that **it is almost impossible to predict weld strength on galvanized steel parts from visually observing the weld zone.**

FIGURE 3

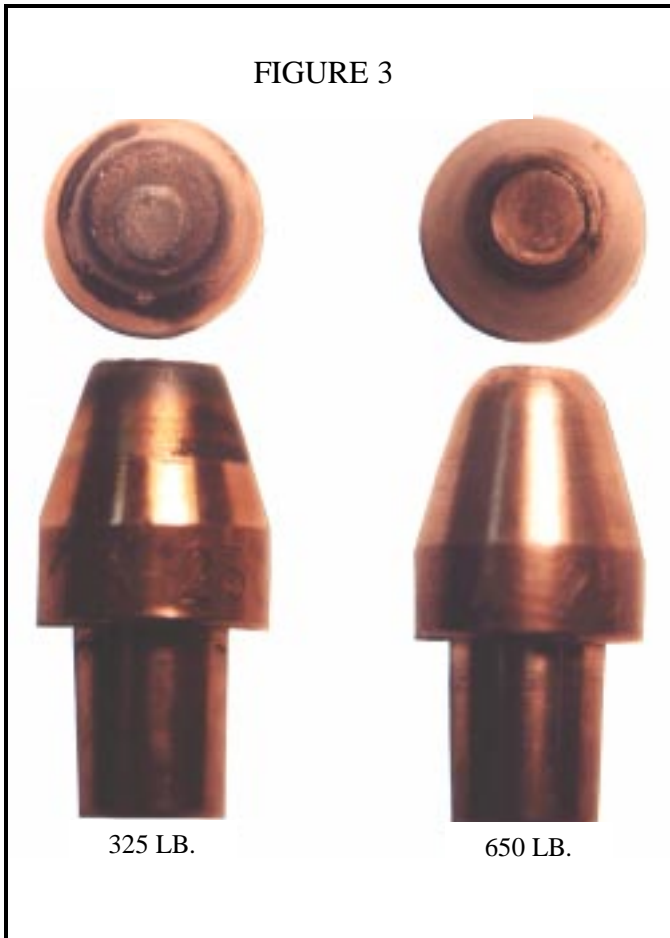

CHART 3 also follows the nugget diameter compared to electrode force. The 820 lb. force weld did not pull a nugget at all and only had a surface weld.

METHODS FOR DYNAMIC ELECTRODE FORCE MEASUREMENT

Most resistance welding machines are operated using SQUEEZE TIME as an artificial delay period between welder initiation and the start of weld current flow.

If the SQUEEZE TIME is TOO SHORT, electrode force will be too low at the beginning of the heat cycle, and as noted earlier in this paper, metal expulsion, poor surface appearance, and low electrode life will result.

FIGURE 4 shows a digital oscilloscope scan of a weld that has started long before full force has been achieved. Trace 1 shows electrode force. Trace 2 is the weld current.

If the SQUEEZE TIME is TOO LONG, the increased time per sequence will reduce the quantity of welds produced during a shift but will not effect the quality.

DIFFERENTIAL PRESSURE ON CYLINDERS:

Electrode pressure is created by the **differential** air pressure

CHART 1: .029 CRS

FORCE	TENSILE	NUGGET DIA.
400	500	.254
500	460	.233
600	400	.227
700	390	.149
800	340	.136
900	300	.122
1000	110	0
1100	0	0

acting on the welding cylinder. The formula is:

$$\text{ELECTRODE FORCE} = (\text{PSI TOP} - \text{PSI BOTTOM}) * \text{EFFECTIVE CYLINDER AREA}$$

PSI TOP is the pressure acting on the top of the air cylinder piston, and PSI BOTTOM is the pressure acting on the underside of the cylinder piston

If the cylinder is mounted on a scissors type welding gun, the calculated number must be multiplied by the mechanical advantage of the welding gun.

MECHANICAL PRESSURE SWITCH USE:

A MECHANICAL PRESSURE SWITCH is used by many manufacturers to delay start of weld heat. They are mounted so as to measure the air pressure on the TOP of the piston. FIGURE 5 shows how this device is installed. As shown in the graph of this figure, while the pressure switch shows the air pressure building quickly, the actual DIFFERENTIAL PRESSURE on the cylinder builds more slowly. Therefore, the use of a single sided pressure switch or even a single sided transducer would be virtually useless in this system.

In fact, to even use such devices, a flow snubber, as shown in the diagram, is installed ahead of this switch to artificially slow the response. Since this does not connect the switch output to reality, its use is not much better than the artificial SQUEEZE TIME and only protects the welder from operation when **no** air is present.

Additionally, mechanical pressure switches have very poor

CHART 2: 050 CRS		
FORCE	TENSILE	NUGGET DIA.
650	1200	.261
750	1050	.151
850	1000	.065
950	1000	0
1050	950	0
1250	800	0
1350	680	0
1450	510	0
1500	300	0

CHART 3: .031 G90		
FORCE	TENSILE	NUGGET DIA.
420	550	.252
520	490	.253
620	250	.189
720	150	.158
820	110	0
920	0	0

WELDER INERTIA

It should be noted that each type of welder mechanism has a certain INERTIA resulting from the mass of the components. On large welders doing straight spot welding, this effect is not major. However on small precision welders, cross wire welding, and projection welding, the ability for the electrode force to be maintained throughout all heat cycles of the weld is critical.

As seen in FIGURE 8, the distance the ram travels increases rapidly during the welding of this cross wire product. If the mechanical system cannot follow this change fast enough, electrode force will be much lower than required during the critical nugget development period and will result in excessive metal expulsion, voids in the weld, and unpredictable weld strength.

repeatability. Using the graduated scale on such a switch will only give "neighborhood" values. This means that changing a mechanical pressure switch for a new job presents a "trial and error" project to the operator. It is for this reason that these switches are typically operator set to a very low value and, effectively, have no control over when welding current will start to flow.

USE OF DIFFERENTIAL PRESSURE TRANSDUCER:

A DIFFERENTIAL PRESSURE TRANSDUCER provides a solution to this problem. As shown in FIGURE 6, a differential pressure transducer accurately measures the difference between top and underside air psi. As the graph next to the figure shows, the transducer response exactly matches the actual electrode force. This type of approach also eliminates the necessity for mechanical setting when it is integrated into the welding control system.

FIGURE 7 shows an oscilloscope picture of a welder that utilizes a differential transducer to start welding at the point when electrode force (2) has reached the maximum value of the air system setting. In this example, the welding control was set with SQUEEZE TIME = 00. This allowed welding to start at the earliest time after initiation and still have secure electrode force.

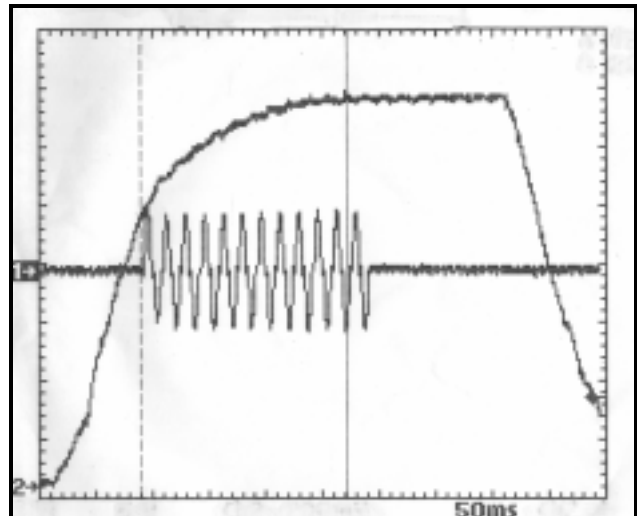

FIGURE 4: WELD BEGINS BEFORE PROPER ELECTRODE FORCE IS REACHED

The basic rule is to keep the mass and cylinder size as small as possible to accomplish the required force and mechanical strength in the weld.

WELDING WITH HIGH DYNAMIC FORCE

As discussed earlier, it is also important to prevent HIGH ELECTRODE FORCE from occurring during the weld cycle. FIGURE 9 illustrates a weld made under conditions where force continues to rise during the weld and exceeds the desired value. Because this rise decreases resistance between the parts being joined, heat generated will diminish.

ELECTRONIC AIR REGULATORS:

No discussion of electrode force would be complete without mention of alternate methods used to set air pressure. While most welders use manually set air pressure regulators, the ability to have this setting done automatically is desirable in many applications.

While designs vary greatly between manufacturers, all systems utilize an electronic signal from the welding control (as shown in FIGURE 10) to change the air pressure regulator setting. This regulator replaces the manually set regulator normally used in a typical air system.

On single point pedestal or portable gun welders, manual setting of the air regulator is usually sufficient for most applications. However where the part being welded requires joining of various thickness combinations at locations on the weldment, use of a common electrode force will compromise the weld strength, appearance, and ductility.

Also many companies, even where the same thickness is being joined, require that welding programs be stored

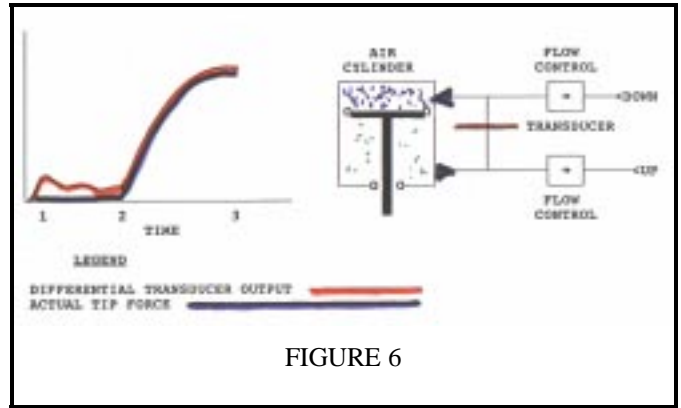

FIGURE 6

Another good application for electronic pressure setting is with **ROBOTIC WELDERS**. If the robot weld gun is joining various metal combinations on the same part, the ability to change "on the fly" can be the difference between secure and dependable welds at all locations and borderline ones. Companies, such as automotive seat manufacturers, find this ability to join wire to sheet, wire to wire, and sheet to sheet on the same part using the correct weld programs and electrode force a major push towards dependable weld output.

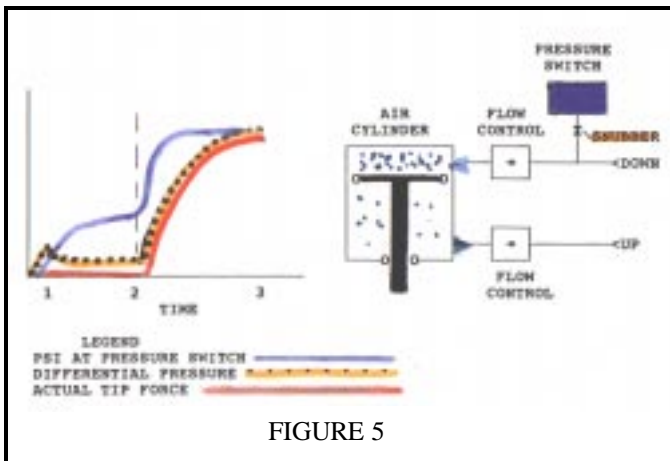

FIGURE 5

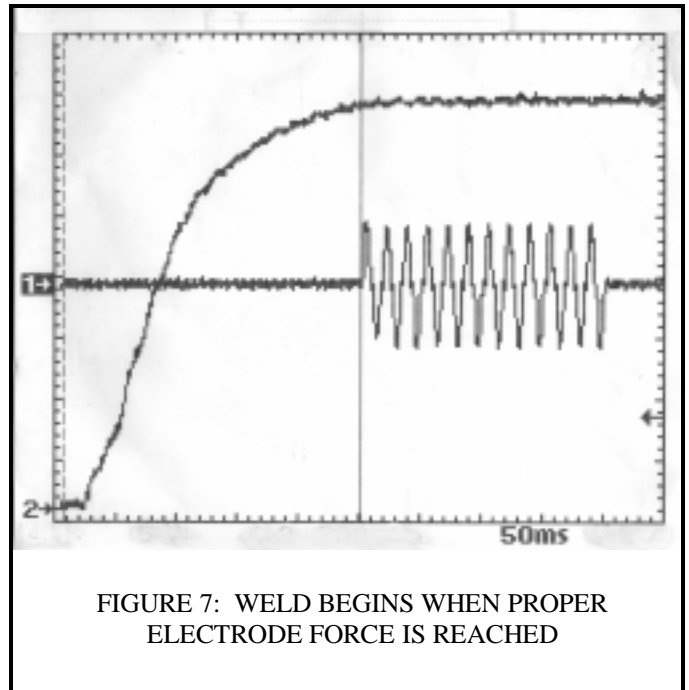
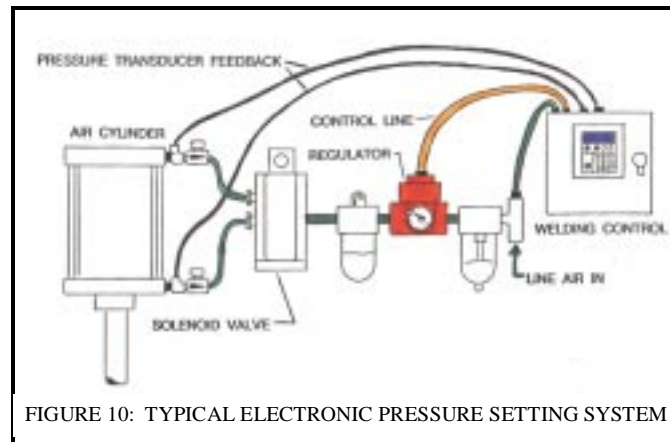
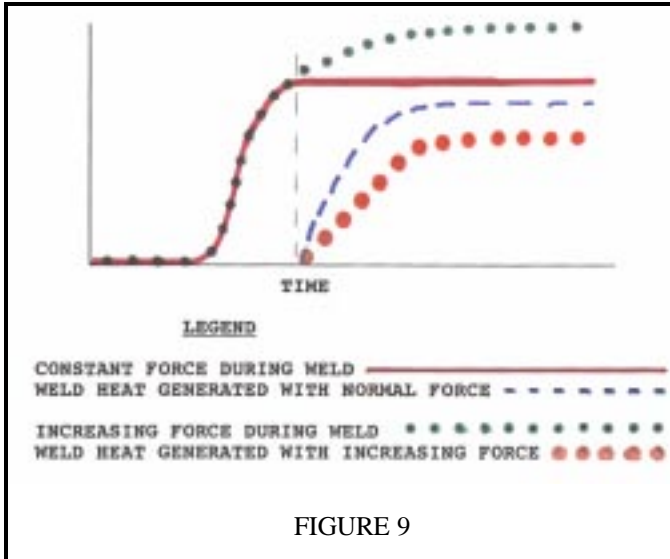
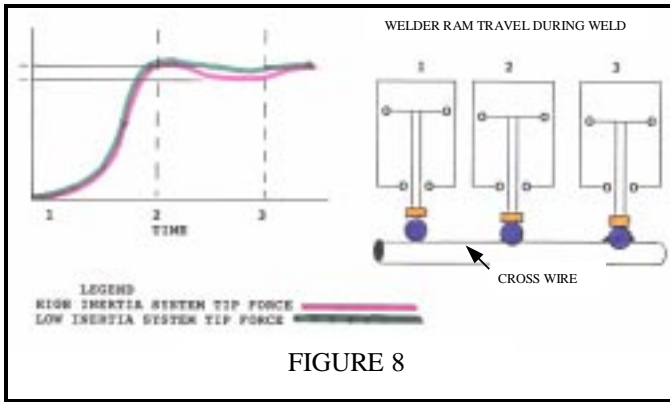

FIGURE 7: WELD BEGINS WHEN PROPER ELECTRODE FORCE IS REACHED

completely and remove the possibility that the operator will change the electrode force. This means that a previously approved weld program can be selected using a few keystrokes to set the welder time, heat, and electrode force.



CONCLUSIONS:

1. Expulsion from an electrode can be caused by either low electrode force or starting weld current flow prior to reaching correct electrode force.
2. Excessive electrode **indentation** occurs from **low** electrode force creating high surface heat under the electrode and allowing plastic flow of the nugget zone.

3. **Low** electrode force causes **high localized heating** at the electrode tip to burn away copper and thus greatly increase the electrode contact area.
4. **Insufficient** force at the electrode creates conditions that produce **inconsistent welds**. This is especially important for poor fitting parts or when welding thick metal.
5. **Low** electrode force on **projection welds** reduces tensile and tends to remove part of the projection as expulsion.
6. **High** electrode force reduces heat created within the nugget area to greatly reduce **penetration**. This results in low tensile strength welds that have poor ductility.
7. Nugget diameter diminishes rapidly as electrode force increases.
8. On galvanized metal, nugget tensile and diameter is even more sensitive to high electrode force than CRS. It is often not possible to visually tell the difference between a solid nugget weld and one with no penetration by viewing the weld zone.
9. Understanding equations for calculation of electrode force from various pneumatic systems allows accurate setting of air systems.
10. Since electrode force is derived from the differential pressure on an air cylinder, use of a mechanical pressure switch will give false results. A differential transducer or load cell is required to allow precise starting forces for each weld sequence.
11. If a welder has a high inertia, the electrode cannot follow the weld nugget as it expands and contracts. This will produce expulsion and reduce electrode life. This is most important with projection and cross wire welding.

REFERENCES:

1. Resistance Welding Manual, Fourth Edition, RWMA, Figure 2.2



T. J. SNOW CO., INC.
1-800-NOW-SNOW
<http://www.tjsnow.com>

T.J. Snow is an Authorized Unitrol Distributor.